



GRESHAM



# BROMLEY 24/7

PRODUCT DATA SPECIFICATION



GRESHAM

# BROMLEY 24/7

## PRODUCT DATA SPECIFICATION

A chair that offers superb comfort and functionality.

### Materials

Seat boards are produced from laminated plywood with pre-fitted threaded 'T' Nuts' for accurate mounting points.

The boards are covered with CMHR (Combustion Modified High Resilience) flexible Polyurethane foam for comfort and compliance to flammability requirements.





Upholstered back boards are produced from Polypropylene copolymer that is covered with a similar foam to the seats. These are upholstered in fabric which is available in a wide selection of colours, patterns and weaves. This assembly is covered to the rear with a Polypropylene outer back.

Structural elements, such as mechanisms, back bars or side chair frames are manufactured in steel. These are produced from various tubular or flat sheet sections and finished in either an epoxy powder coating or chrome finish depending upon the model.

### Considerations

- Reflex foam seat structure
- Optional headrest
- Height adjustable backrest
- Optional arms
- Class 4 Gas Lift (150kg)
- Optional polished Aluminium base
- Synchronised, side tensioning mechanism

### Technical Details

				
Model	AXR24/7	AXR24/7A22	AX24/7	AX24/7A22
OA Height	1205-1360	1205-1360	1015-1175	1015-1175
OA Width	680	705	680	705
OA Depth	680	680	680	680
OA Arm Height	-	610-860	-	610-860
Seat Height	510-610	510-610	510-610	510-610
Seat Width	520	520	520	520
Seat Depth	590	590	590	590

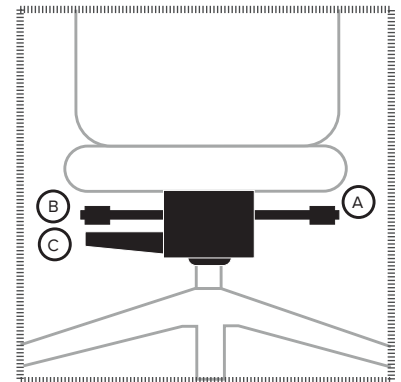



### 24/7 MECH

- A - Lever: Lockable Seat Slide / Button: Mechanism Limiter
- B - Lever: Seat Height Adjustment / Button: Lock
- C - Mechanism Tension Adjustment

Environment 

Certification 

Quality 

98% Recyclable 

Maximum Load Per Seat 

Fabric Choice 

Guarantee 

Based on 24/7 fabrics 